

COMUNE di PONZANO DI FERMO
PROVINCIA DI FERMO



Progetto di ristrutturazione, riqualificazione e adeguamento alla normativa vigente in materia di sicurezza e prevenzione incendi della scuola dell'infanzia e primaria "Gianni Rodari"

PROGETTO ESECUTIVO



LOCALITA' ... via F. Maggini

PROGETTISTA
scendoni studio associato
ing. Maurizio Scendoni
collaboratore
ing. Riccardo Scendoni

TAVOLA	OGGETTO	SCALA
4a	ELABORATI GRAFICI _ piante _ prospetti _ sezioni _ stato attuale	1:100
		DATA 11/02/2018

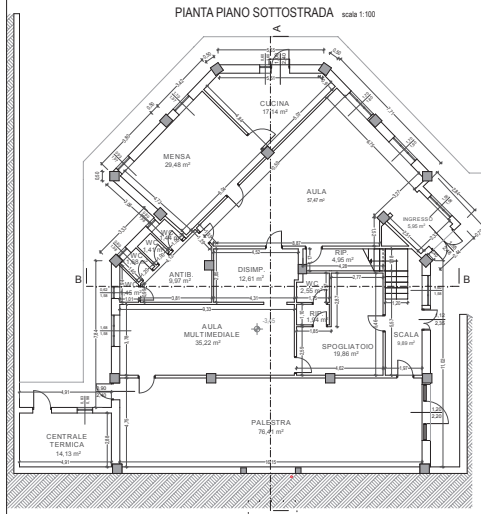

PROSPETTO SUD

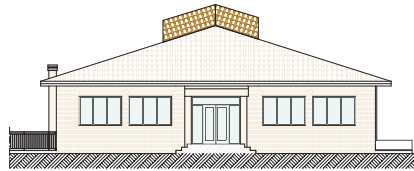

PROSPETTO NORD

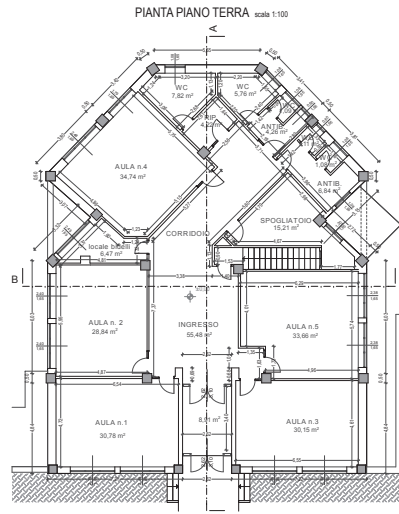
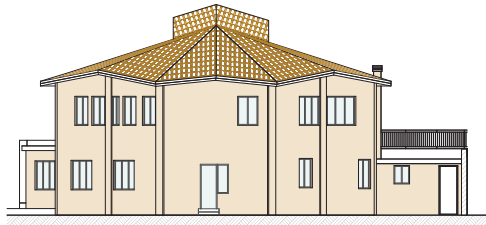

PROSPETTO EST

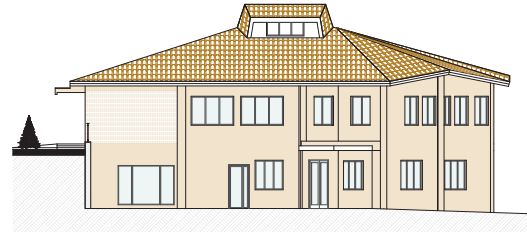

PROSPETTO OVEST

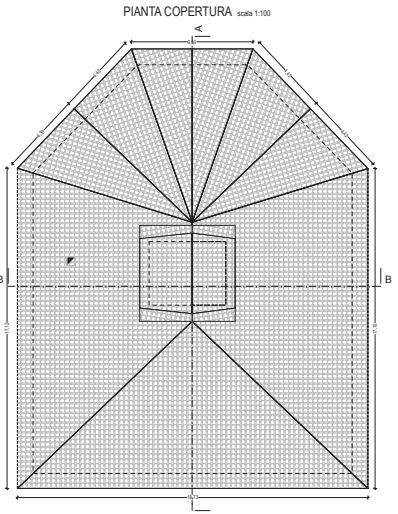
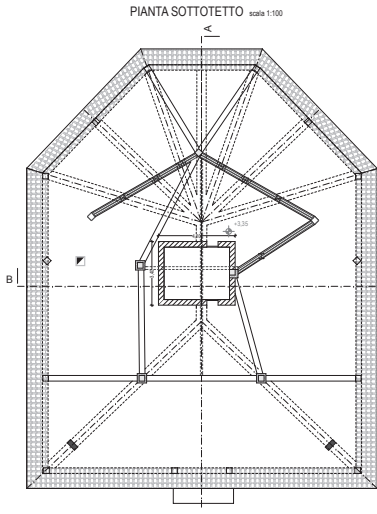
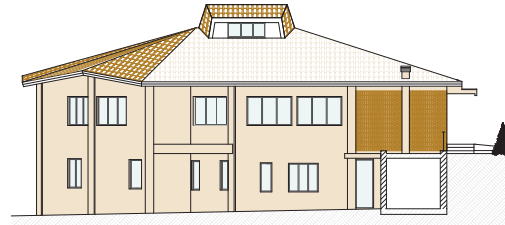

SEZIONE A-A scala 1:100

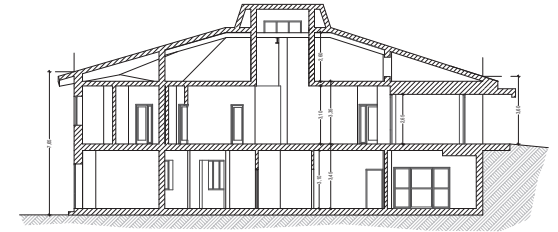

SEZIONE B-B scala 1:100

